

Love of life begins with "Rcom"

REPTILE BROODER

Ver. 1.2

DIGITAL REPTILE BROODER USER'S MANUAL MX-BS700R / MX-BL700R



Rcom





How to use Rcom REPTILE BROODER

1. Introduction	
(1) Safety precautions	4 ~ 7
(2) Identification of Parts and Composition	
(3) Name & Function of Operation Parts	
(4) Easy Function Operation	
2. Brooding	
(1) Installation Environment	8 ~ 11
(2) Instructions for Installation	
(3) How to Terminate Incubation	
(4) Dew Condensation	
3. Function Settings	
(1) Return to Factory Setting	11 ~ 15
(2) Temperature, Humidity Setting	
(3) How to turn ON/OFF UV LAMP	
(4) How to change UV lamp time	
(5) How to use indoor outlet	
(6) How to change outlet time	
(7) How to change Cels./Fahr.	
(8) How to turn ON/OFF Sound	
4. How to Clean	
(1) Instructions for Disassembling and Cleaning	16 ~ 17
5. Product Information	
(1) Specification	18

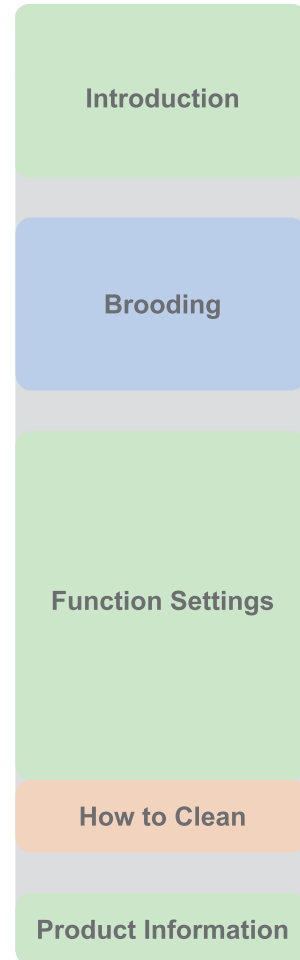

⚠ The manufacturer, or the vendor does not take responsibility for any loss of animal life or property damage caused by user's carelessness, remodelling/painting, changing purpose of use, outage, and etc. In order to avoid malfunctions, please use after carefully reading the user's manual.

Mark Explanation

- Caution :** Caution mark against a fault that can cause damage, trouble, or failure of incubation.
- Prohibited.
- Do not disassemble.
- Do not touch.
- It is necessary to keep.
- Remove the power cord from outlet.
- Ground Connection for preventing electric shock.
- Tip :** References or useful suggestions in using Rcom product
- CAUTION** Warning of actions which may be dangerous or cause damage to the incubator.

Electrical hazards

CAUTION Be careful the details below when you use.

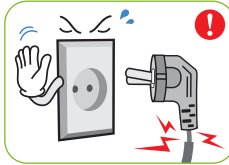

Do not use a damaged power cord or loose outlet.

▶ Risk of electric shock or fire.

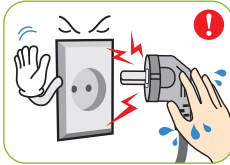

Do not pull the cord when taking out the power cord, and keep wet hands away from connecting plug.

▶ Risk of electric shock or fire.

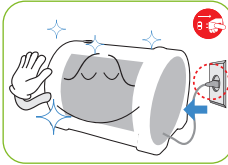

Never pull the plug out of the outlet during the incubation period.

▶ Incubation will be interrupted.

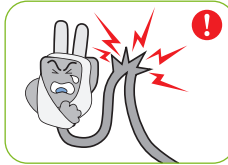

Do not twist or crush electric cord.

▶ Risk of electric shock or fire.

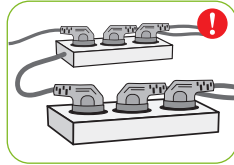

Do not insert multiple connecting plugs in an outlet.

▶ Risk of fire or electrical overload.

Setting Cautions

CAUTION Be careful the details below when you use.



Do not use for man.

▶ Injury or death hazard

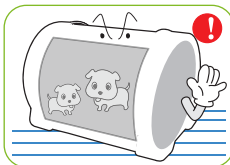

Do not leave an animal alone for a long time with the door closed.

▶ Death hazard



Do not install in dusty or dirty environment.

▶ Risk of damage or fire within the machine.

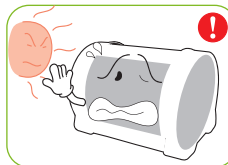

Do not install under the direct sunlight.

▶ Risk of fire or interference with the incubation process.



Do not install in moist or humid environment.

▶ Risk of fire or electric shock.



Do not install in excessively cold or hot conditions, cigarette smoke, etc.

▶ Risk of interference with operation.

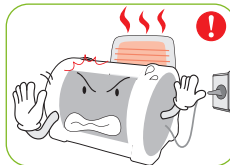

Install away from heat sources.

▶ Risk of damage to the machine case and interference with operation.

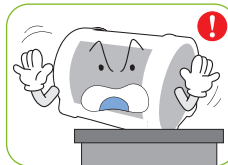

Ensure that the machine is installed on a stable surface away from edges.

▶ Risk of damage to machine and eggs and user from accidental knocks or drops.



Do not turn the machine upside down.

▶ Water will pour out of the machine, and view window can be dropped or damaged.

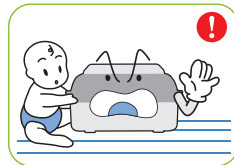

Do not install where children or other people can touch with easy.

▶ Risk of knocking the incubator or accidental interference with the controls.

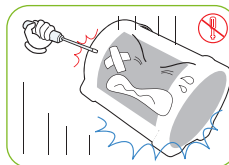

Do not disassemble or modify the machine in any way.

▶ Risk of electric shock or fire.



Please ensure that no small objects get into the holes on the machine.

▶ Risk of electric shock or fire.

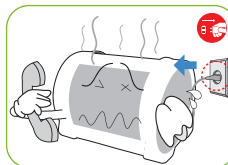

If the machine sounds strange or emits smoke contact your service center.

▶ Risk of electric shock or fire.



Do not use for high-priced animals.

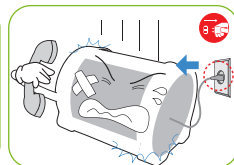

If the machine requires repair disconnect from the power supply and please contact to your service center.

▶ Risk of electric shock or fire.

Cleaning Cautions

CAUTION Be sure to disconnect the electric cord from the outlet before cleaning.

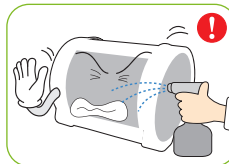

Do not spray cleanser directly on the incubator surface.

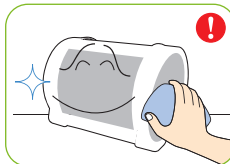

Clean the incubator by a soft cloth with a neutral detergent.



Brush away dust on the plug with a dry cloth.



Do not use chemicals like wax, benzene, alcohol, thinner, aromatic, or lubricant, etc.

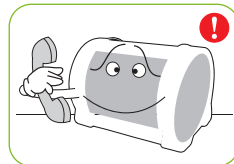

For special cleaning of inner part per year, contact to the service center.

▶ If you don't clean the inside of incubator for a long time, dust can cause some trouble or a fire.

Identification of Parts



Basic Components



Manual



Power cord



(Mounted)

3 air filters



Silicon tube (1.5M)



UV Lamp

Sold Separately

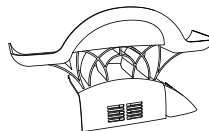





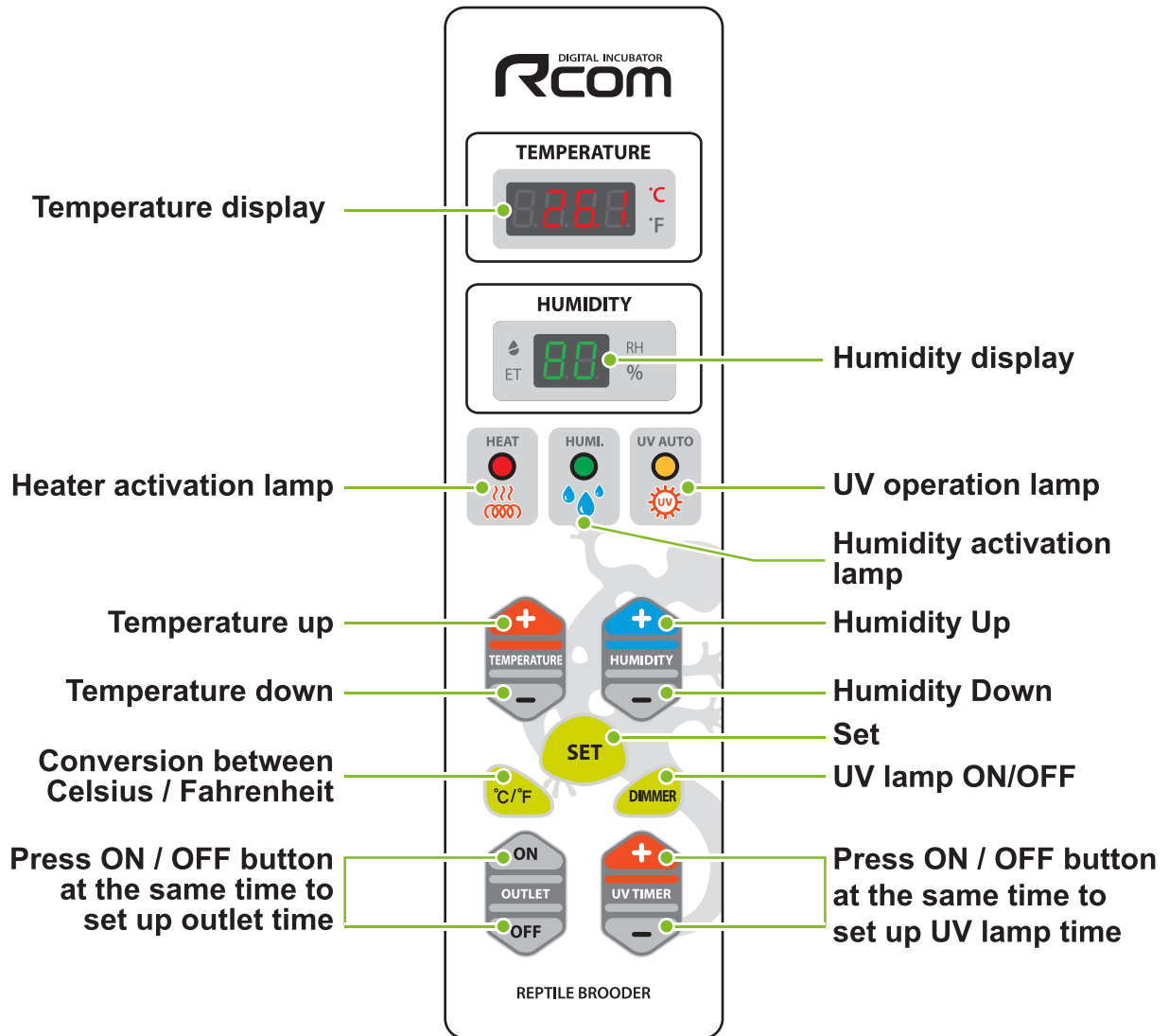









Brooder standing

Name & Function of Operation Parts



Easy Function Operation

		How to turn off ventilation fan manually	  A.OFF (FAN OFF) Keep pressing Temperature Down button until "H.OFF" appears. Then, press once again so that "A.OFF" appears.
Temperature setting	  Set temperature to the required figure	How to turn off humidification device manually	  U.OFF (HUMIDITY OFF) Keep pressing Humidity Down button until "UOFF" comes out.
Humidity setting	  Set humidity to the required figure	How to change outlet time	[Setting range : OFF, 1~24hours]  Out (Outlet) Press ON and OFF buttons simultaneously to be shown "Out" on display then, starts setting mode. Press "ON" button in once, 1 hour unit of time is going up, Press "OFF" button to going down the time in unit of 1 hour . If you press "SET" button to save the setting.
Factory setting	   rst		How to change UV lamp time
How to turn off heater manually	  H.OFF (HEATER OFF) Keep pressing Temperature Down button until "H.OFF" comes out.		

Installation Environment

CAUTION Be careful the details below when you use.

Rcom Brooder is designed and manufactured to provide convenient use to customers through latest digital control technology. However, the following requirements must be followed, otherwise it may have fatal effects on the animal. The inside environment of the Brooder is largely affected by the installation environment and the equipment is recommended to be installed in a place where there are minimal noise and shock. An environment with small temperature difference with the surrounding temperature ranging from 20 to 25°C (68~77°F) and humidity level of 40~60% is recommended. Careful monitoring is required as the temperature can drop rapidly during the night time. The Brooder must not be exposed to direct sunlight.

Instructions for Installation

- ⚠ Please operate the equipment sufficiently and check to make sure that the equipment is functioning properly before putting in the animal.
- ※ The equipment may not be automatically controlled by the environment condition it was set up with if it is not in the outside environment condition of where the product was installed (Temperature: 20~25°C (68~77°F) / Humidity: 40~60%).
- ▶ Remove the vinyl cover on the front of the sight class, then take out the tray and slowly remove the vinyl cover on the inside.

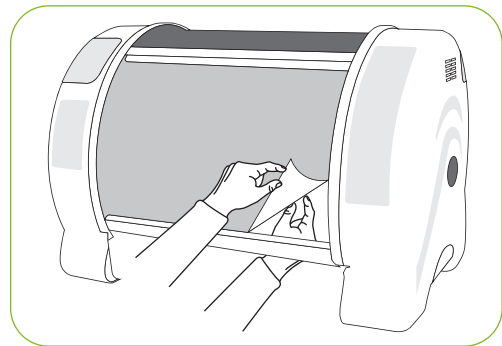

- ▶ Please loosen a screw of right side of filter by using a screwdriver.

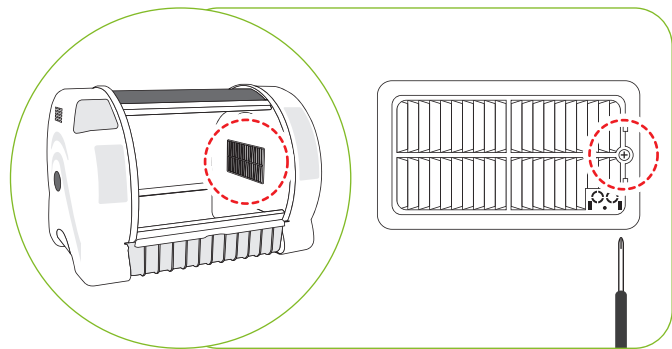

- ▶ Separate cover by bending Picture (a), (b) to the left at the same time and using your fingers or a screwdriver, then pulling in the direction of Picture (c) and pulling to the front of direction in Picture (d). At this point do NOT completely remove the silicon hose from the cover, but follow Picture (e) which will allow easier assembly (using tools will help).

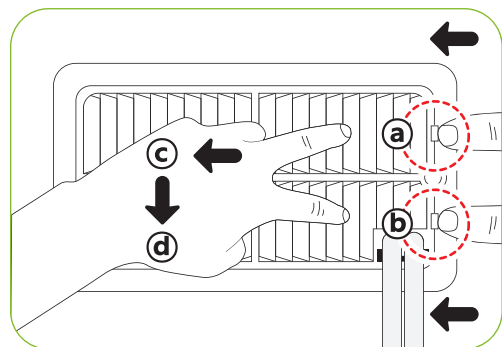

- ▶ Please check end of floate switch [Fig-2] in humidity tank [Fig-1] whether it moves to up and down by using your fingers.
When the products are stored long time, the float switch may not work smoothly.
- ▶ After using Brooder, if you don't use Brooder for about one month, please check end of floate switch whether it moves to up and down by using your fingers.

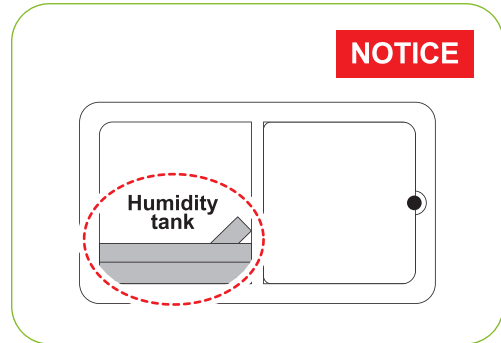

[Fig-1]

⚠ If float switch doesn't work properly, the water may overflow.

- ▶ After checking float switch, please assemble a filter like the reverse of disassemble.

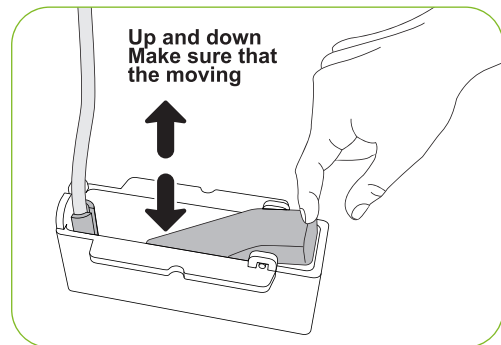

[Fig-2]

[How to UV lamp assemble]

- ▶ Put UV lamp into socket on the left, turn left to lock.

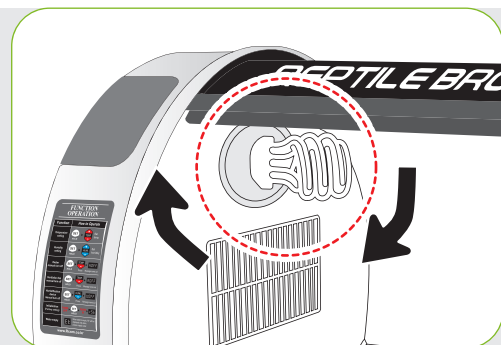

- ▶ Open the water cap on the back right side and plug the silicon hose into the nipple as in [Fig-A], then plug the tip into a filled humidifying water container (sold separately). Fill the water case after installing the product in a place you want, since moving the product when it is filled with water may cause product malfunction.

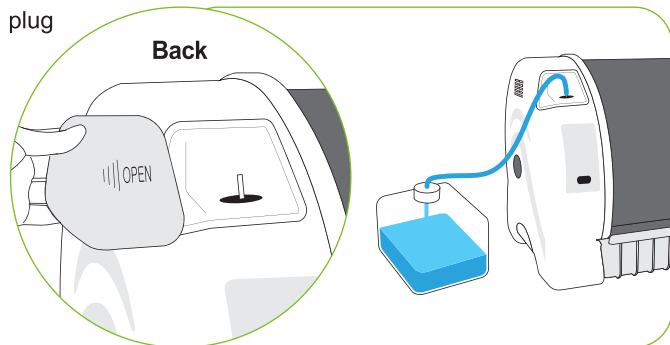

[Fig-A]

- ⚠ Do not place the humidifying water container on top of the Brooder when using.

- ⚠ If you use Mineral water or Tap water for humidification, the humidity tank can be broken easily because of water scales. We strongly recommend you to use only "DISTILLED WATER" for your machine, and Autoalex Co.,Ltd & our distributors do not indemnify for warranty service not only if you have any problem with using mineral water, regular water, tap water and the like but also if you had improper management or handling for your machine. In this case, Autoalex Co.,Ltd. & our distributors will charge for your after service.

- ⚠ Water can leak onto the floor if the height of the water container is higher than the sticker on the side.

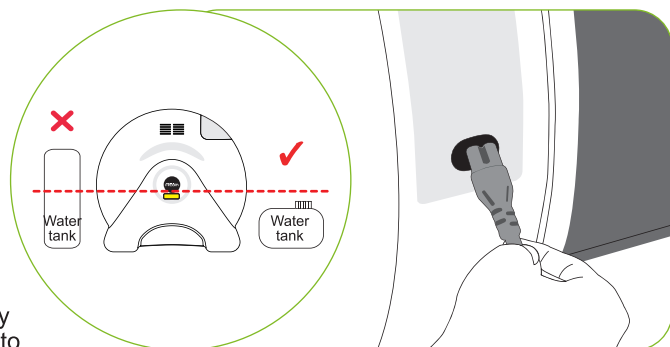

[Fig-B]

- ▶ The equipment operates when the power cord is connected to the back of the main body as in [Fig-B] and the power plug is connected to the power outlet .

How to Terminate Brooding

- ▶ There is no separate power switch on this product. The equipment turns off when the power cord is unplugged.
- ▶ To start using again, simply re-connect the power.
- ▶ You can operate the equipment on minimal consumption power if you turn off the temperature function and humidity function.

Dew Condensation

- ▶ In case of large temperature difference between equipment interior and installation environment, water can leak onto the window, tray or the floor. This is a natural phenomenon and may happen more severely under more humid conditions. To minimize condensation effects, the equipment must be installed in a place where the temperature difference between equipment interior and installation environment is small.
- ▶ If the equipment is turned off in the middle of operation, humidity remaining inside the equipment may cause water drops (dew) to stick on to the surface. To prevent this, the equipment should be turned off after the internal humidity is eliminated by emptying the humidifying water container and running the equipment for about one hour before turning it off.
- ▶ If not using the equipment for a long period of time, open the window on equipment and dry the interior of the equipment for about a day in a well-ventilated place.

※ The electronic areas of the equipment are treated with special coatings against humidity.

Return to Factory Setting

- ▶ Used to initialize equipment to a setting when it was first released from the factory in case where the input value is changed due to mal-operation of equipment.
- ▶ If you unplug the power cord and re-plug while the SET button is pushed, "rSt" will appear on the display unit and the equipment will be initialized to a setting when it was first released from the factory.

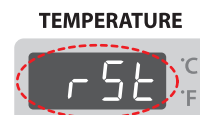
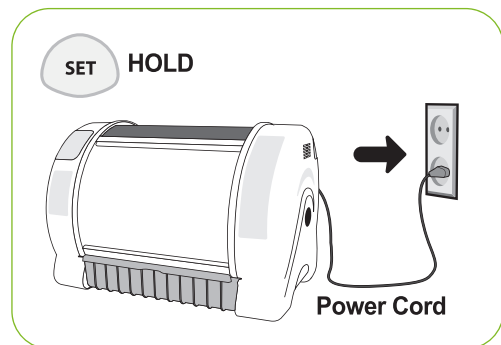

Temperature Setting

- ▶ Set the temperature using the TEMP+/TEMP- button while the SET button is pushed. The selected value is automatically entered when the button is released.

[Instructions for setting heating function ON/OFF]

ON : Set the temperature to 20°C or higher by pushing the TEMP+ button while the SET button is pushed.
[Default : ON]

OFF : After setting the temperature to 20°C or higher by pushing the TEMP+ button while the SET button is pushed, pushing the TEMP- button once will stop the heating function and H.OFF will appear on the display unit.

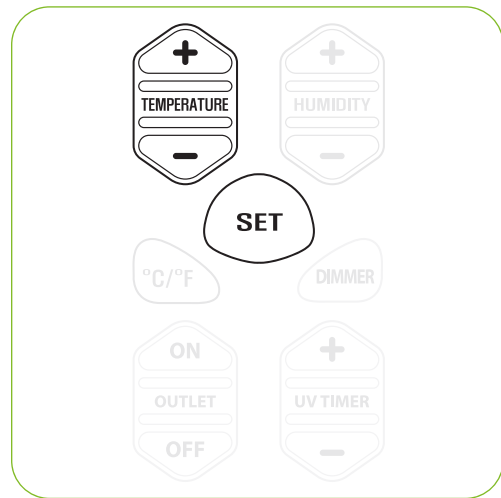
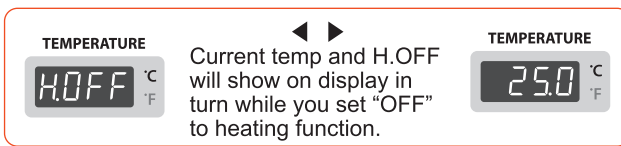

[Instructions for setting ventilation function ON/OFF]

ON : Set the temperature to 20°C or higher by pushing the TEMP+ button while the SET button is pushed.

OFF : Pushing the TEMP- button when the heating function is OFF will stop the ventilation function and A.OFF will appear on the display unit.

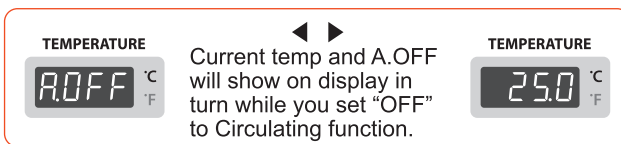

- ※ The display unit shows current temperature even when the heating and ventilation functions are stopped. When the ventilation fan is stopped, there might be slight deviation between the displayed temperature and the actual temperature as air is poorly circulated.

Humidity Setting

- ▶ Set humidity using the HUMI+ / HUMI- button while the SET button is pushed. The selected value is automatically entered when the button is released.

[Instructions for setting humidifying function ON/OFF]

ON : Set the humidity to 40% or higher by pushing the HUMI+ button while the SET button is pushed.
[Default : ON]

OFF : After setting the humidity to 40% or higher by pushing the HUMI+ button while the SET button is pushed, pushing the HUMI- button once will stop the humidifying function and U.OFF will appear on the display unit.

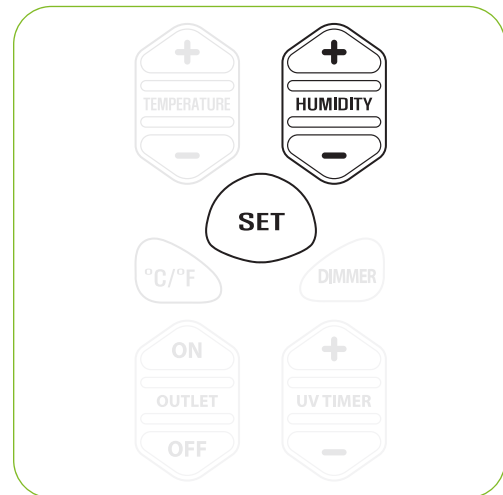
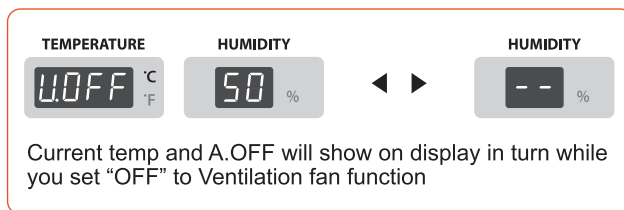

Please be sure to re-fill the water when "Et" alarming on the display

- ⚠ please set "off" to heating in case you do not want to activate the heating, Heating unit lifespan will be more longer.

※ The display unit shows current humidity level even when the humidifying function is stopped. When the ventilation fan is stopped, there might be slight deviation between the displayed humidity and the actual humidity as air is poorly circulated.

- 💡 When releasing from the factory, temperature and humidity was corrected to be optimized according to international standard. If necessary, recorection is possible, however, it isn't desirable for users to correct it directly. In case that correction is necessary, please contact Rcom homepage (www.Rcom.co.kr → data center → Instruction manual category) or place where you purchased to inquire about it. As low price thermometer and hygrometer easy to purchase in the open market have much deviation of estimate value, it is desirable to use corrected thermometer and hygrometer for exclusive use.
[thermometer and hygrometer for exclusive use – See Rcom homepage]

How to turn ON/OFF UV LAMP

- ▶ Press "DIMMER" button then, you can turn UV lamp on or off.

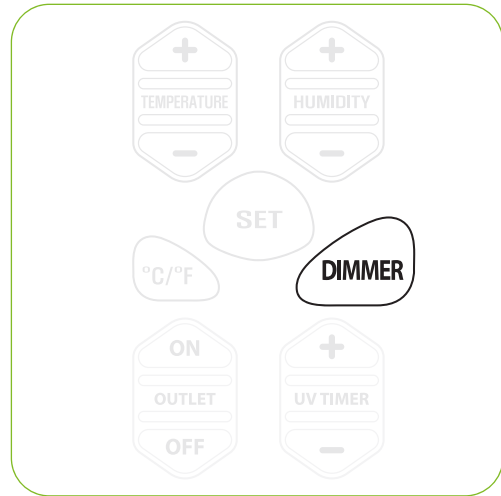

How to change UV lamp time

- ▶ Press + and - buttons simultaneously to be shown "LEd" on display then, starts setting mode. Press "+" button in once, 1 hour unit of time is going up, Press "-" button to going down the time in unit of 1 hour. If you press "SET" button to save the setting.

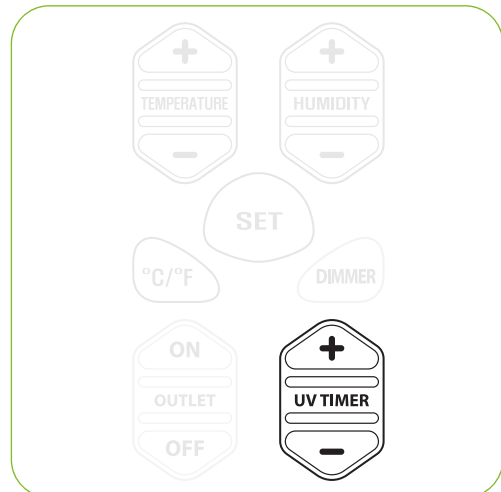

How to use indoor outlet

- ▶ You can put plug into socket on the right side of the product. It does not match the shape of plug and concentric plug, an adapter must be purchased separately for use.

⚠ The allowable load is 100W or lower.
The use of outlet above the allowable load can cause the failure or fire. Be careful about that.



How to change outlet time

- ▶ Press ON and OFF buttons simultaneously to be shown "Out" on display then, starts setting mode. Press "ON" button in once, 1 hour unit of time is going up, Press "OFF" button to going down the time in unit of 1 hour. If you press "SET" button to save the setting.

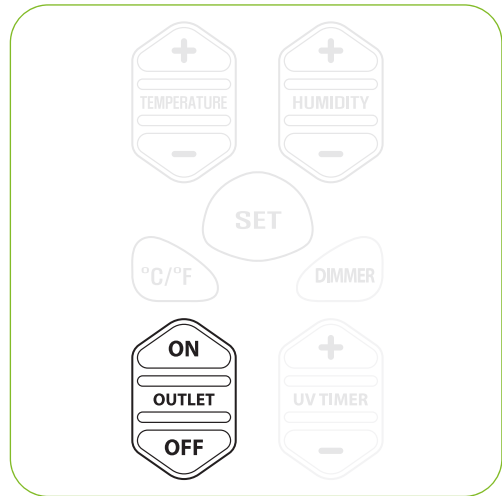

How to change Cels./Fahr.

- ▶ If you push the °C/°F button, the LED will blink alternatively from "°C" ↔ "°F". [Default setting : °C]

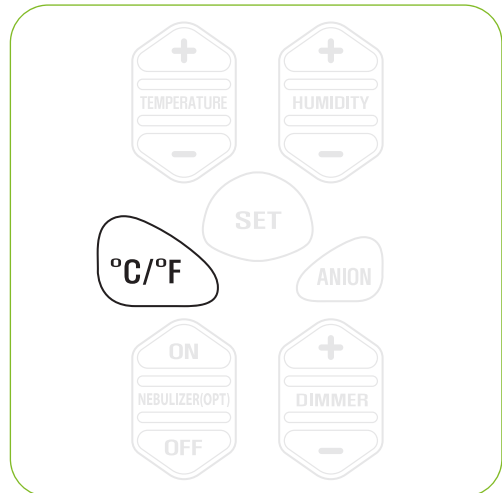
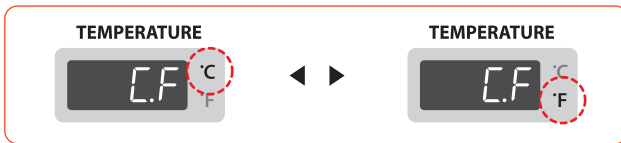

How to turn ON/OFF Sound

ON : If you push the TEMP+ button for 5 seconds all sounds are turned on and "S.ON" will appear on the display unit. [Default : ON]

OFF : If you push the TEMP+ button again for 5 seconds all sounds are turned off and "S.OFF" will appear on the display unit.

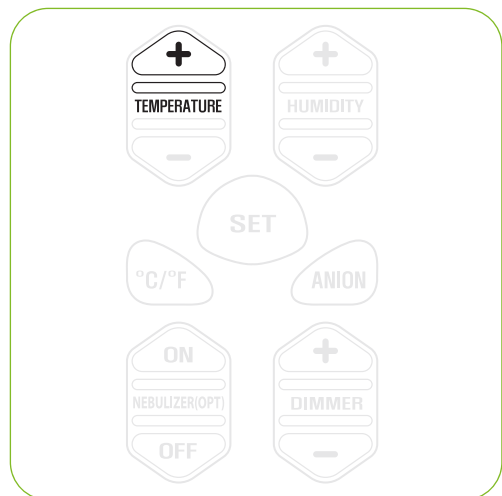
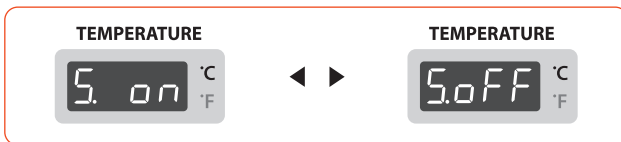

Instructions for Disassembling and Cleaning

⚠ The Brooder power cord must be separated from the power outlet.

- ▶ pull out the power cord from the connection jack on the back and disconnect the power plug from outlet.

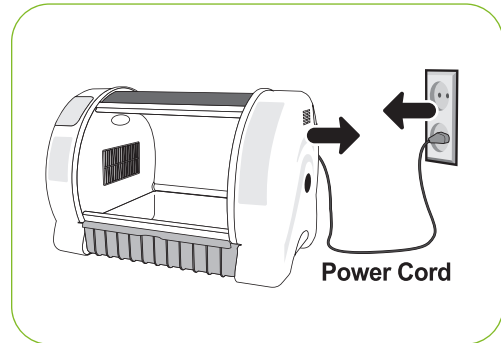

⚠ Take UV lamp away from socket, keep it in safe place.

- ▶ Unscrew with driver.

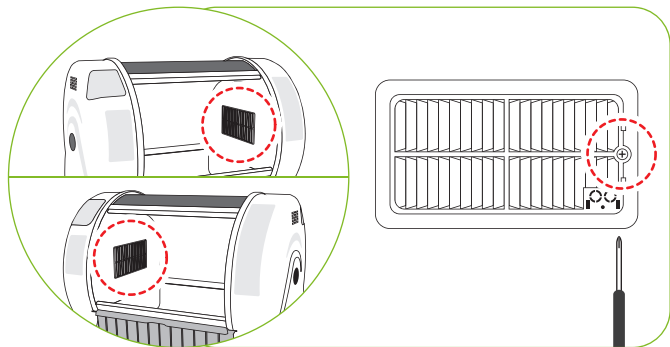

- ▶ Separate cover by bending Picture ①, ② to the left at the same time and using your fingers or a screwdriver, then pulling in the direction of Picture ③ and pulling to the front of direction in Picture ④. At this point do NOT completely remove the silicon hose from the cover, but follow Picture ⑤ which will allow easier assembly (using tools will help).

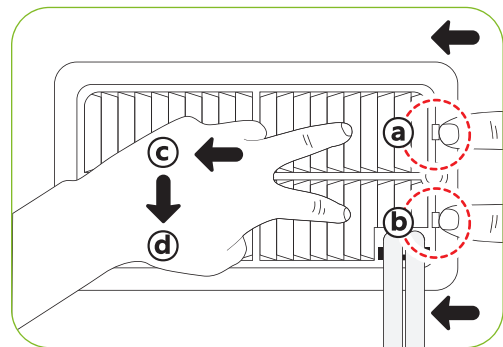

- ▶ Brush and wash.

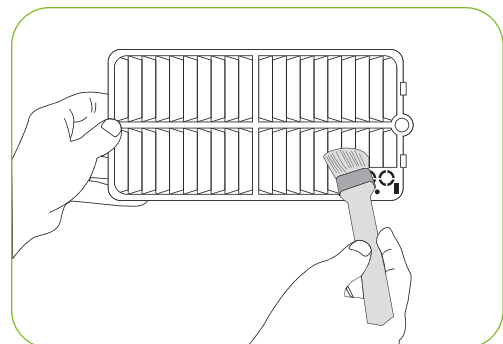

- ▶ Take out the humidifying container in the direction of the arrow. Take out the air filter, wash thoroughly with water and dry. [Fig-1]

⚠ Please do not touch the humidity unit. It can cause body burn.

⚠ Cleaning cycle of air filter and humidifying container : Air filter should be washed with water once every week and replaced every 6 months~1 year. (May vary according to time of usage) The humidifying container should also be washed once every week.

⚠ It is recommended to use distilled water in order to minimize debris (scale) from collecting around the humidifying container. If you wish to use different water please ask your vendor first. (Underground water and lime water cannot be used) Clean once every week. Humidifier malfunction caused by debris(scale) collected around the humidifying container from poor cleaning is considered to be the customer's fault and repair will be charged even during the warranty period.

- ▶ Remove connector. Be careful that the connector ③ does not go into the equipment. [Fig-2]

- ▶ Take out float ④ by slightly spreading using your hand and clean the scale inside humidifying container. [Fig-3] (Clean once every week)

- ▶ Thoroughly clean the inside of the humidifier once every week. If not cleaned well the water level sensor (float switch) will not work and cause malfunctions. (Repair for humidifier malfunction due to poor cleaning will be charged even during the warranty period)

- ▶ Plug silicon tube into ⑤ of humidifier in [Fig-4].

- ▶ Take out the tray and wipe the inner surface of the sight glass with a soft cloth.

⚠ Do not clean the incubators with benzene or thinner, it can cause modify or bleach.

- ▶ Assemble in the reverse order of separation and store.

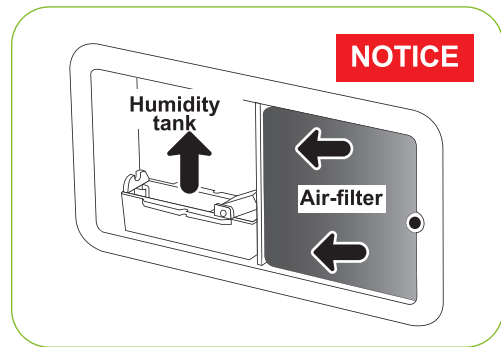

[Fig-1]

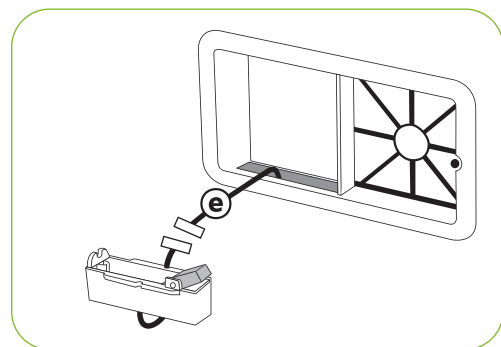

[Fig-2]

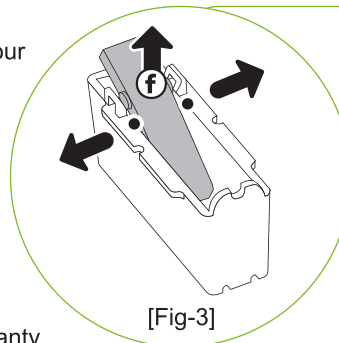

[Fig-3]

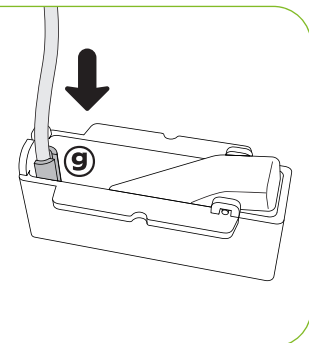

[Fig-4]

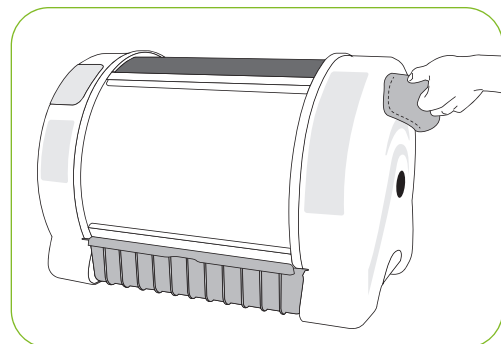

Specification

1-1 Name : Rcom REPTILE BROODER

1-2 Model : MX-BS700R / MX-BL700R

Model. NO	MX-BS700R	MX-BL700R
Power	AC 100~120[V], 50/60[Hz] / AC 220~240[V], 50/60[Hz]	
Temp. Control Range	Ambient temperature ~ 38[°C] (Ambient temperature ~ 100.4[°F])	
Outside Environment Temp.	Optimal range : 20 ~ 25[°C] (68~77[°F])	
Humidity control	40 ~ 60[%] (Subject to change depending on the ambient environment)	
Outside Environment Humi.	40 ~ 60[%]	
Power Consumption	Average 60[W]	Average 75[W]
Product Weight	9.7[Kg]	10.7[Kg]
Product Size	(W)655×(L)470×(H)440[mm]	(W)855×(L)470×(H)440[mm]
FUSE Standard	250[V] 5.0[A] (Ø6*30[mm])	

⚠ We are not allowed to extend warranty therefore we ONLY provide 1 year warranty service. If you do not register, we provide limited warranty service for 1year based on factory releasedate.

⚠ You will be asking for service charge if you are in below cases.

- 1. Broken or Problem caused by 'No cleaning' or 'Improper handling'**
- 2. Broken or problem caused by 'Not using distilled water'**
- 3. Broken or problem caused by 'Trying Reptile hatching in incubator'**
(Please don't try Reptile hatching in incubator. Please use Hatcher during Reptile hatching.)
- 4. Broken or problem caused by 'Wrong controlling(Using)'**
- 5. Broken or Problem caused by using the machine out of User's Manual.**
- 6. Broken or problem caused by 'Customer's mistake or fault'**

※ Product Registration Procedures

If you are a new member of Rcom, you need to log in our website at www.Rcom.co.kr

1. Click "SIGN UP" on top of the right corner.
2. Fill out the information on the blanks.

If you already registered your information on the Rcom website, please log in to www.Rcom.co.kr.

1. Click "Login" on top of the right corner.
2. Select "Customer" and click "Register Products".
3. Fill out the information on the blanks.

You will need below information to register on our website.

1. Your name
2. Your (home/company) address & Email address, country
3. Your product(model) name & Serial number
4. Date of purchase & Name of purchased shop you bought from



Rcom is designed for user's easy and convenient use.
It can be changed without notice for improvement in performance,
design,treatment, and software, etc.



www.Rcom.co.kr

SELLER

MANUFACTURER

AUTOELEX CO.,LTD.

- OFFICE : 218, Sangdong-ro, Gimhae-si,
Gyeongsangnam-do, 50805 Korea
- TEL : +82-55-337-2561
- E-MAIL : sales@autoelex.com

Rcom is the Best Design with High Quality, Value, and Performance!